



您的工件夾持和自動化解決 方案的合作夥伴

www.hainbuch.com

HAINBUCH
WORKHOLDING TECHNOLOGY

我們的使命

革新工件夾持技術



成立於1951年的德國
家族企業



每年提供超過1000套客
戶訂製的夾持解決方案



擁有超過150項專利技
術和榮獲眾多獎項



全球有超過850名員工

工件夾持解決方案

適用於所有的機械加工工藝



車削



銑削



研磨



齒輪加工



瀚伯格夾具系統

具有驚人的靈活性



安裝時間<2分鐘



夾持裝置

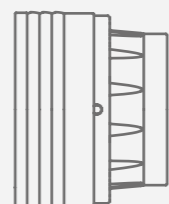

可旋轉式卡盤

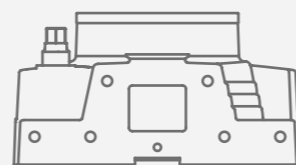

靜止式卡盤

夾持元件和適配模塊



外夾-夾固頭

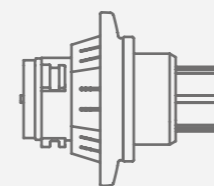

內漲-芯軸模塊

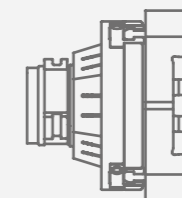

三爪卡盤模塊

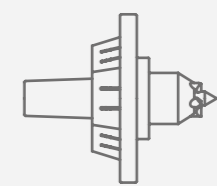

驅動頂針/
莫氏錐度模塊

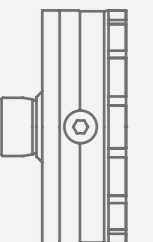

磁力吸盤塊

芯軸

用於強大的內徑夾緊



- 高回轉精度
- 在整個夾持直徑長度上都有極強的夾持力
- 非常易於用戶安裝調試
- 可用於工件五面加工



夾具快換系統

安裝時間<5分鐘



未使用centrotex
快換夾具安裝時約為35分鐘



使用centrotex 快換夾具安
裝時<5分鐘



机床适配器
[在机床主轴端]



外夾卡盤帶夾具適配器



內漲芯軸帶夾具適配器



三爪卡盤帶夾具適配器

- 標準化的快換接口
- 重複定位精度 $\leq 3\mu\text{m}$ - 不需要再次校正
- 需要切換加工的工件可在機床外預先安裝



客製化解決方案

應對每一個工件夾持的挑戰

- 每年有超過1,000個客製的解決方案
- 超過45名設計工程師和我們的研發團隊一起開發專門的夾持解決方案,以滿足客戶在最特殊加工條件下對工件夾持的要求
- 我們50%的訂單來自於客製化的解決方案

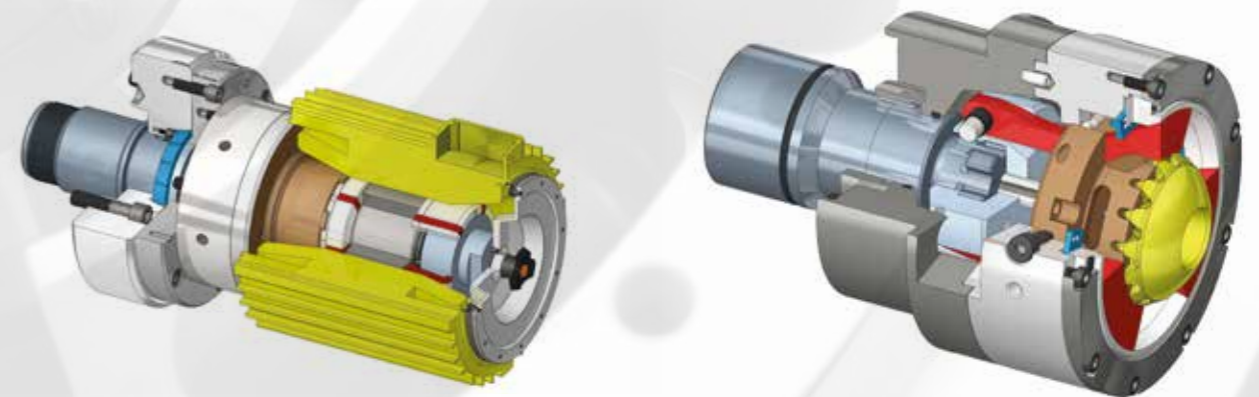

自動化

自動快換夾具AC

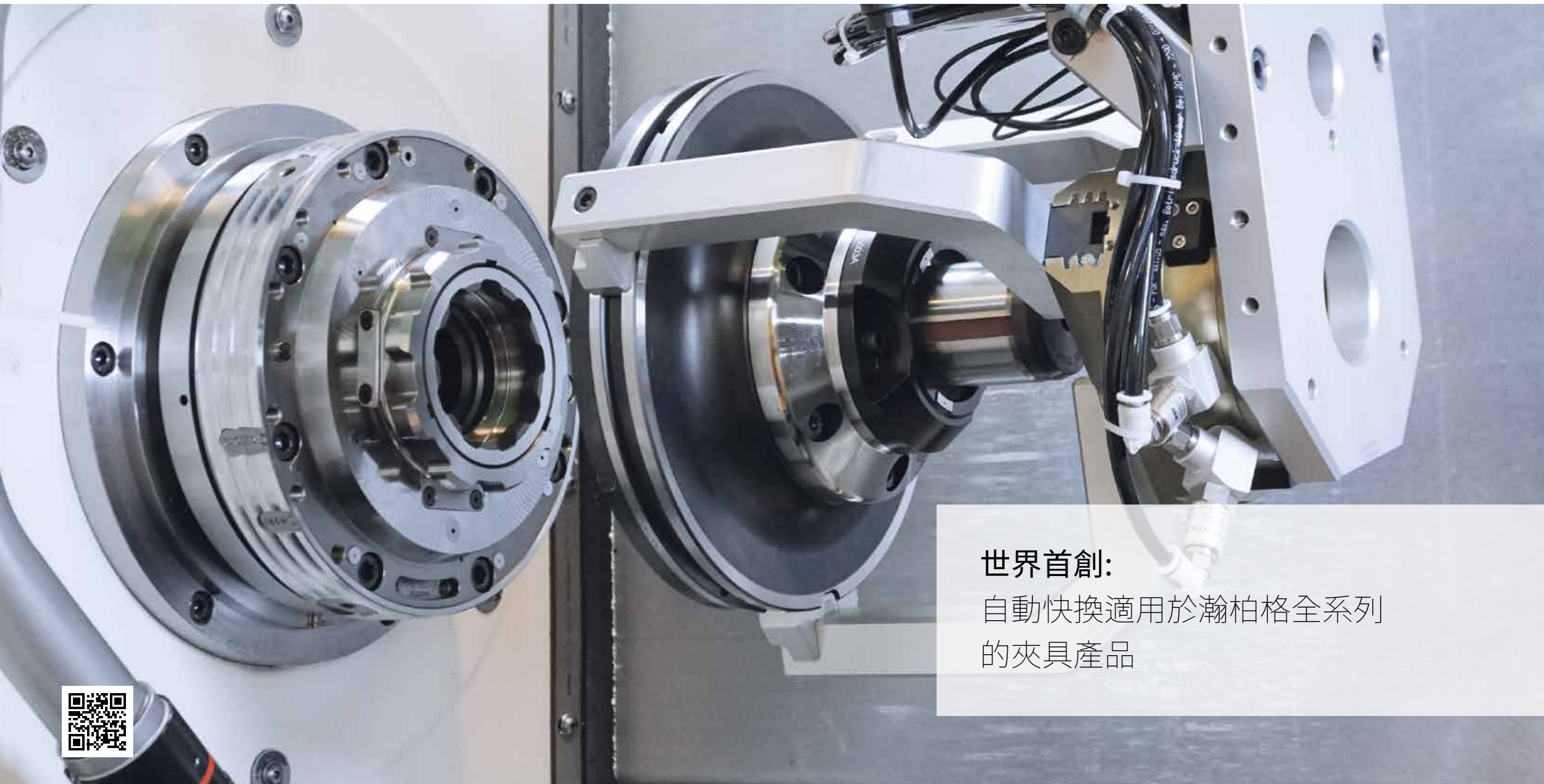

世界首創：
自動快換適用於瀚柏格全系列的
的夾具產品



聯系方式 我們的全球化服務

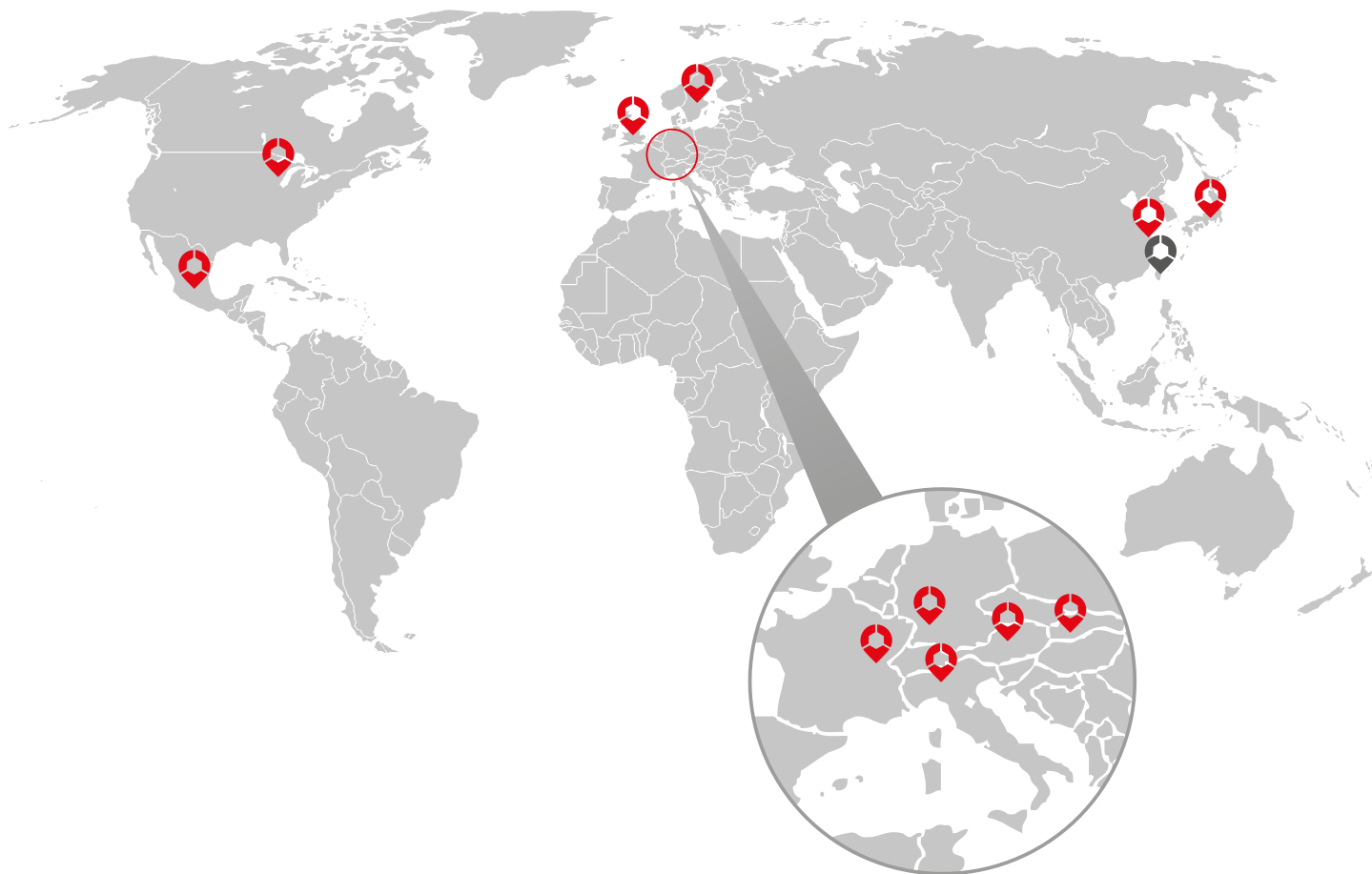

諱鋒貿易有限公司 李育儒業務經理
408252 台中市南屯區寶山里寶山東二街8號11樓之二(發票地址)
Mobile phone : 0919661441 FAX : 04-23813768
E-mail: sales@hf-taiwan.com.tw
<https://www.hf-taiwan.com.tw/>

您的聯系人



柯盈嘉
臺灣銷售代表

Phone: +886 931699348
Roger.Ke@hainbuch.tw



林竝傑
臺灣銷售代表

Phone: +886 926298116
Edward.Lin@hainbuch.tw



Jens Johannsen
國際銷售部負責人

Phone: +49 7144.907-188
Jens.Johannsen@hainbuch.de



Sylvia Rall
首席執行官和所有人

Phone: +49 7144.907-0
sylvia.rall@hainbuch.de